

MENTEŞELİ SİNEKLİK PROFİLLERİ

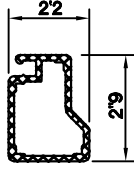

MENTEŞELİ SİNEKLİK PR.
6799.101

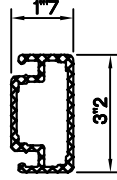

MENTEŞELİ SİNEKLİK ORTAKAYIT PR.
6799.103



SİNEKLİK MENTEŞESİ
E799.131

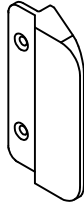

SİNEKLİK TUTAMAĞI
E799.141

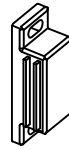

SİNEKLİK ÇİT ÇİT
H799.111

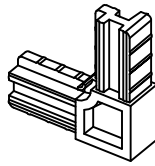
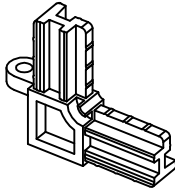
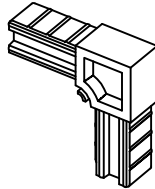
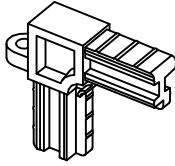
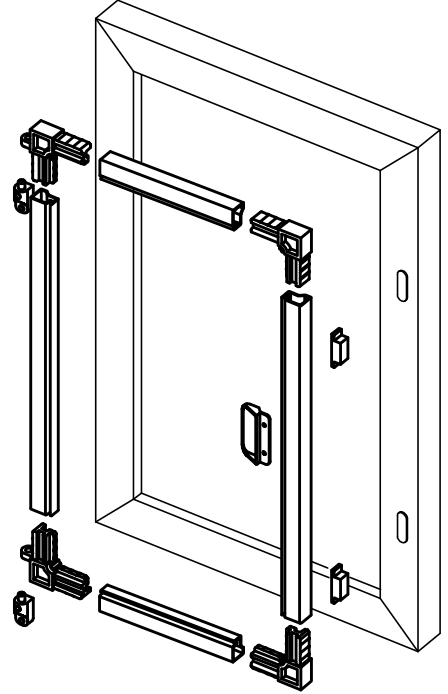

SİNEKLİK KÖŞE BİRLEŞİM PRÇ. (TK)
E799.121

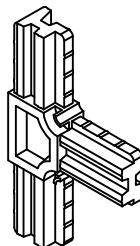
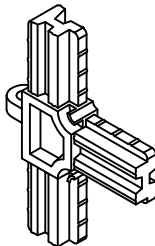

SİNEKLİK ORTAKAYIT BAĞLAMA PRÇ. (TK)
E799.111

